

# SPECYFIKACJA MECHANICZNA

światlik rurowy do podstawy 250

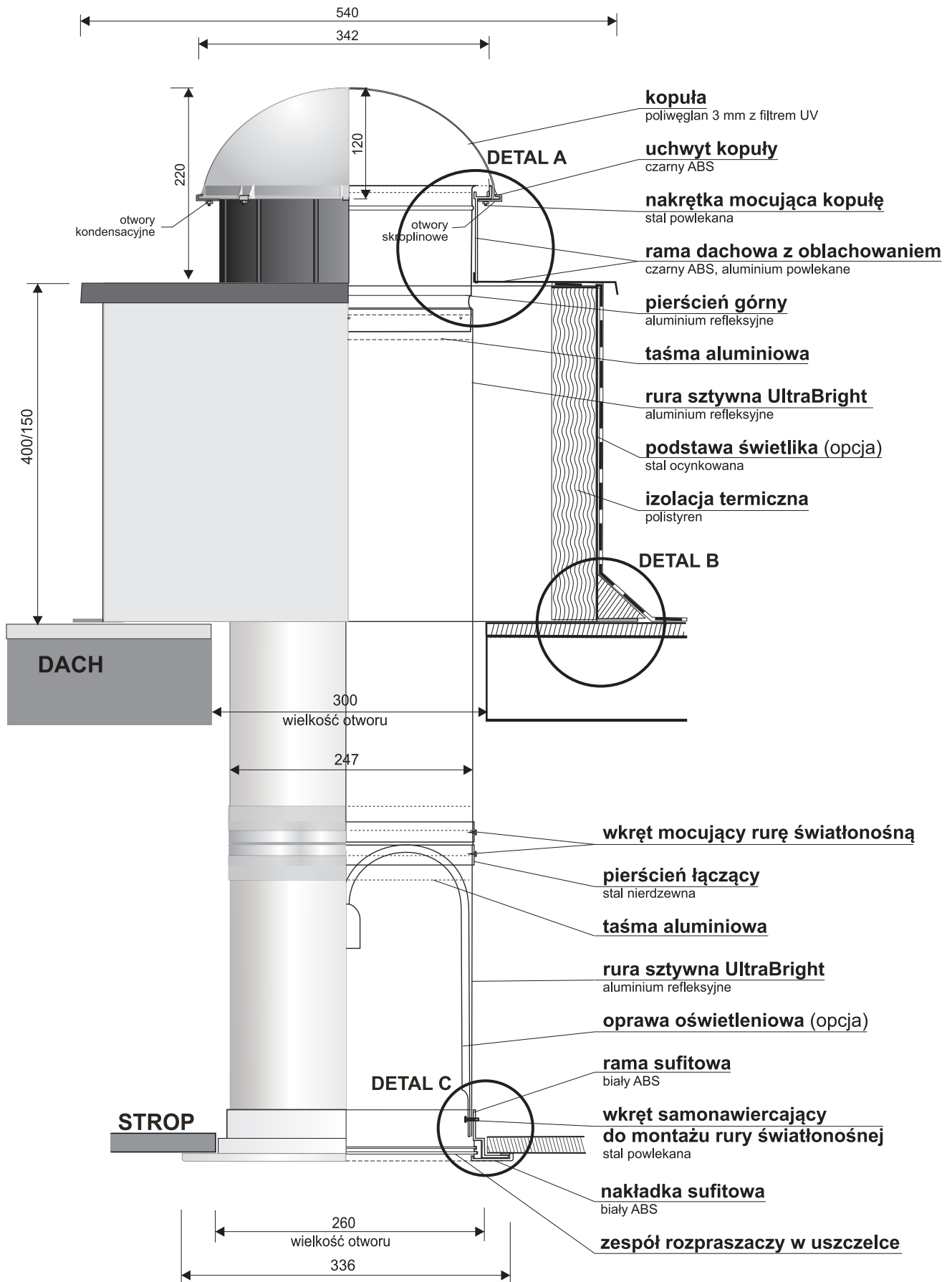

### DETAL A

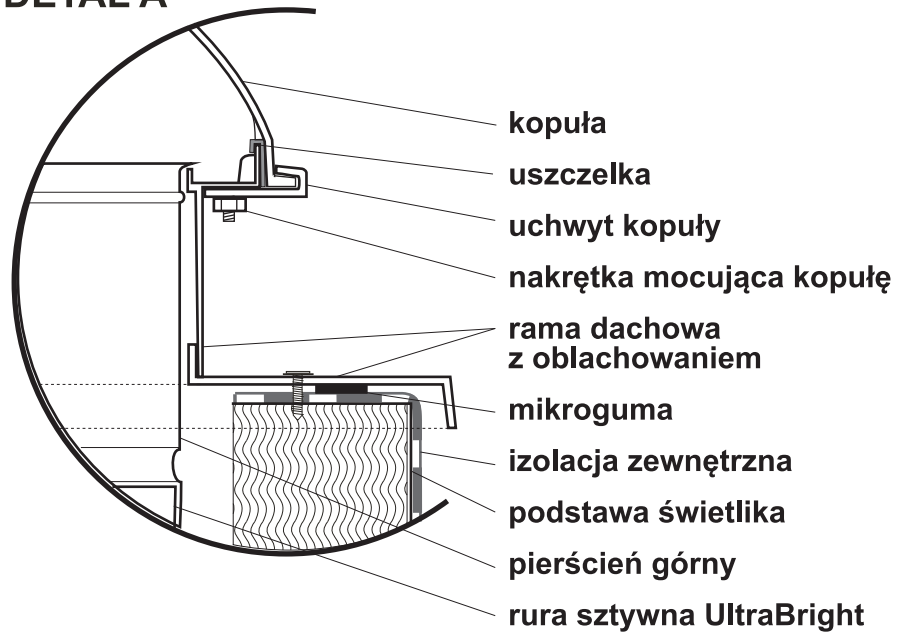

### DETAL B

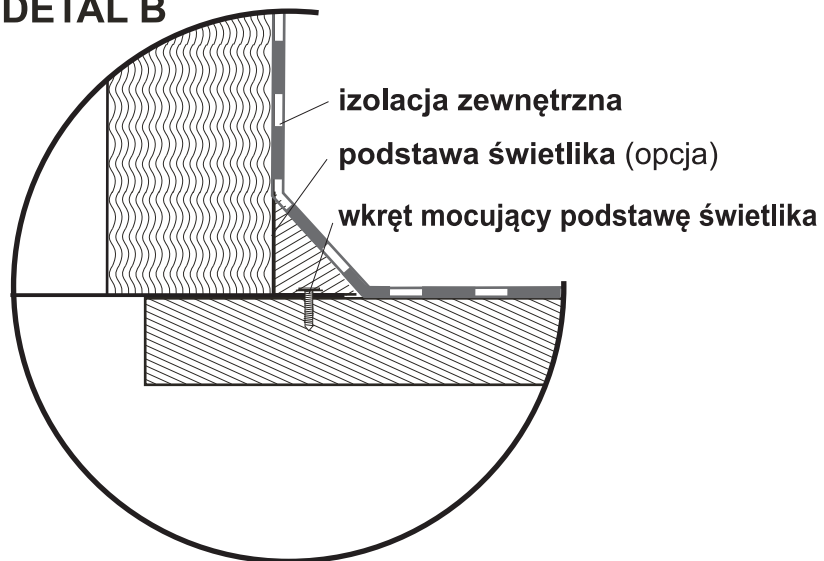

### DETAL C

